

# A Multiphysics Model to Ensure Power Cables are Restrained Safely During Short Circuit Fault

M.S. Yeoman PhD<sup>1</sup>, R. Damodharan<sup>1</sup>, R.J. Varley<sup>1</sup>, L. Frizzell<sup>2</sup>

1. Continuum Blue Ltd., Cardiff, United Kingdom

2. CMP Products Limited, Cramlington, United Kingdom

## INTRODUCTION

Cable cleats are products designed to ensure the retention and support of cables and conductors in large electrical installations. However, more importantly they are designed to withstand high electromechanical forces in the event of a short-circuit fault, whilst maintaining the integrity of the cables without causing damage to equipment or human life. Trefoil cleats are specially designed cable cleats used to hold three single core power cables in a triangular touching formation. Figure 1 below, illustrates some trefoil cleats in use, and two design examples of trefoil cleats.

## AIM

To develop a fully parametrized 3D transient short-circuit model of trefoil cable cleats and assess changes in cable diameter and electrical loads to predict the success, or failure of the cable cleats in real-world installations.

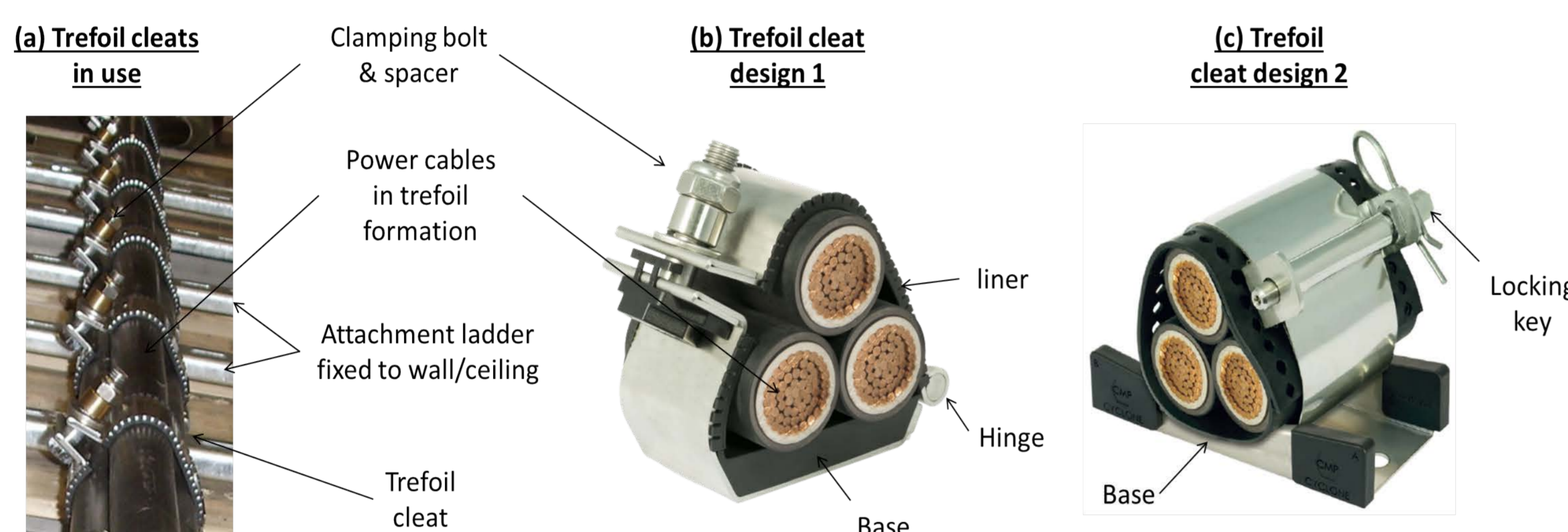

Figure 1. Trefoil cleats in use & variations in trefoil cleat design

## Short-Circuit Testing of Cleats

EN 50368[1] and IEC 61914[2] standards provide details on the testing & certification of cleats to withstand, either one (category 1) or more (category 2) short-circuit tests. The typical trefoil cleat test assembly is illustrated in Figure 2 below, where one end is connected to a three phase supply and the other end is connected to a short-circuiting busbar, with all three-phases being connected. The cables are required to be restrained and fixed to the test mounting at a minimum of 5 equally spaced points along its length and the cleats are mounted to an appropriately selected cable ladder. The duration of the three phase short-circuit test is required to be no less than 0.1 seconds.

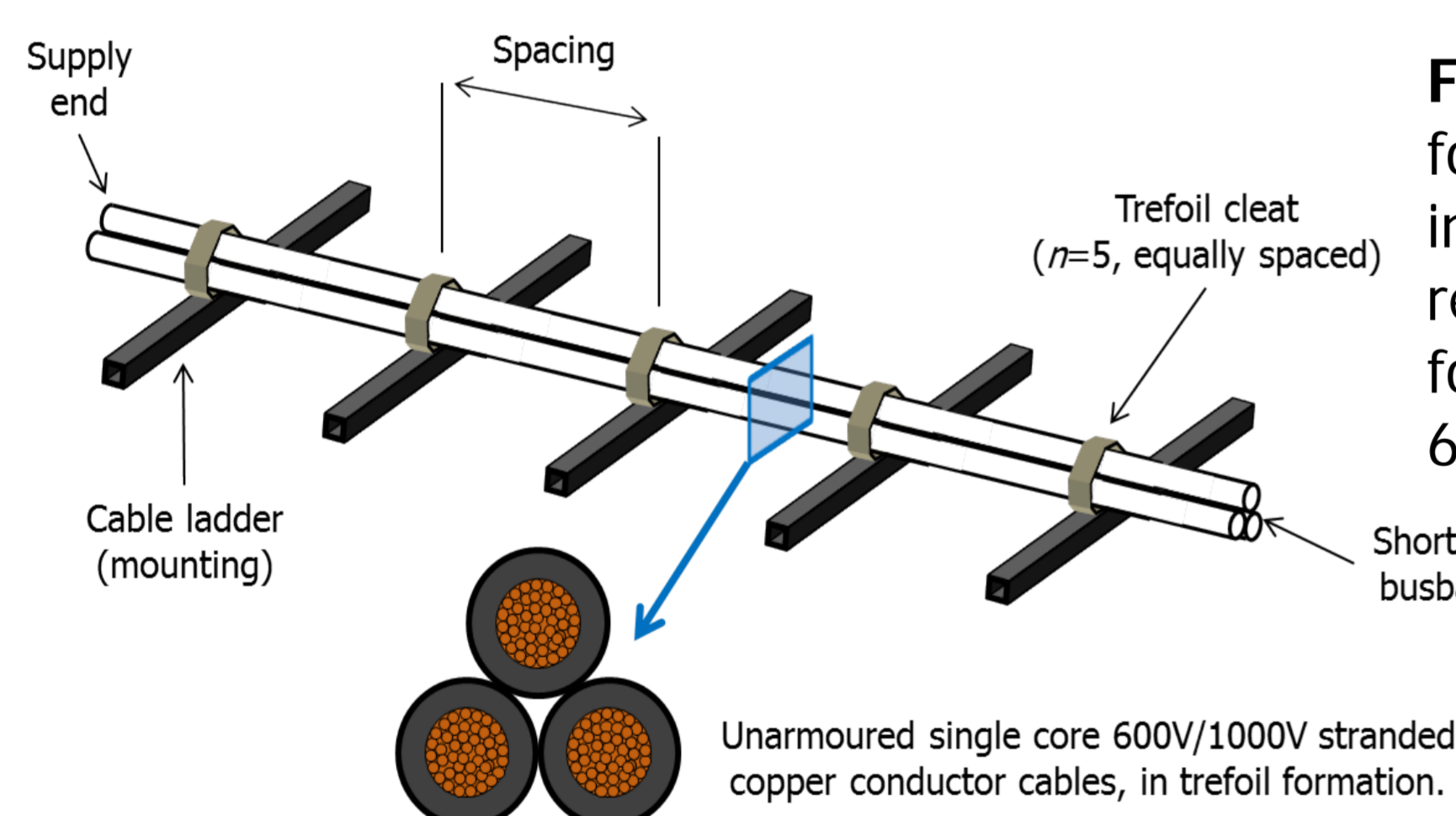
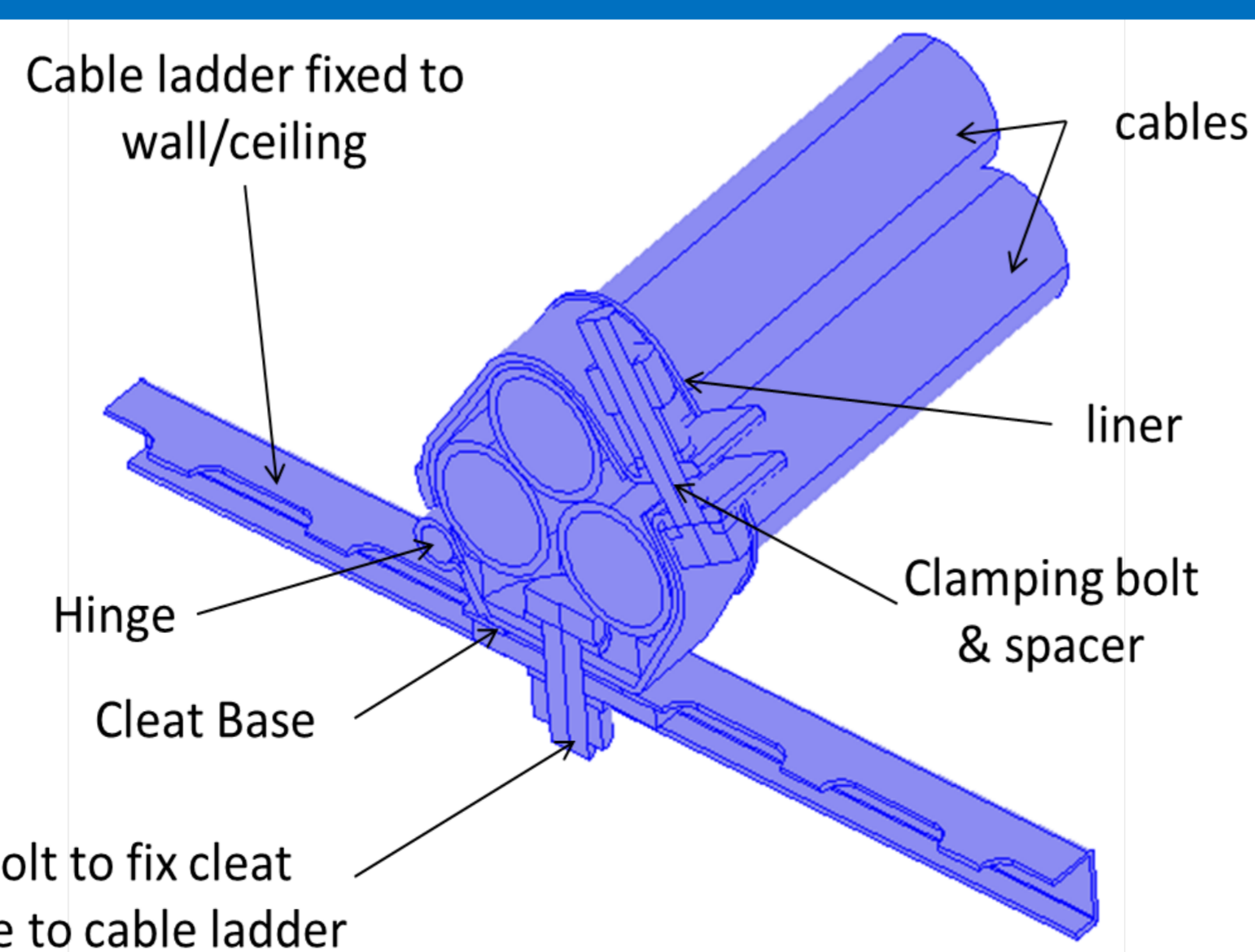

Figure 2. Typical test assembly for trefoil cleats without intermediate restraints for resistance to electromechanical force (adapted from IEC 61914:2015)

## METHOD

A time-dependent multiphysics model of cable cleats being short-circuit tested according to IEC 61914[1] requirements was developed. The model included currents, induced electromagnetic forces, nonlinear materials and contact loading and stresses, and was used to fully describe and simulate the dynamic load conditions on the cables and cleats during a single short-circuit test. Different cleat designs at different electrical loads were assessed. The test parameters from the simulations were then replicated in a physical tests at an independent test laboratory. The test results were then compared to the analytical results obtained from the multiphysics model. Figure 3. illustrates a sectioned view of the geometries of the in the multiphysics model for an installed cable cleat (design 1), highlighting the various components implemented in the model.

Figure 3. Sectional view through trefoil cleat design showing various components utilised in the model



### References:

1. EN 50368:2003 Cable Cleats For Electrical Installations
2. IEC 61914:2015 Cable Cleats & Short-Circuit Calculations

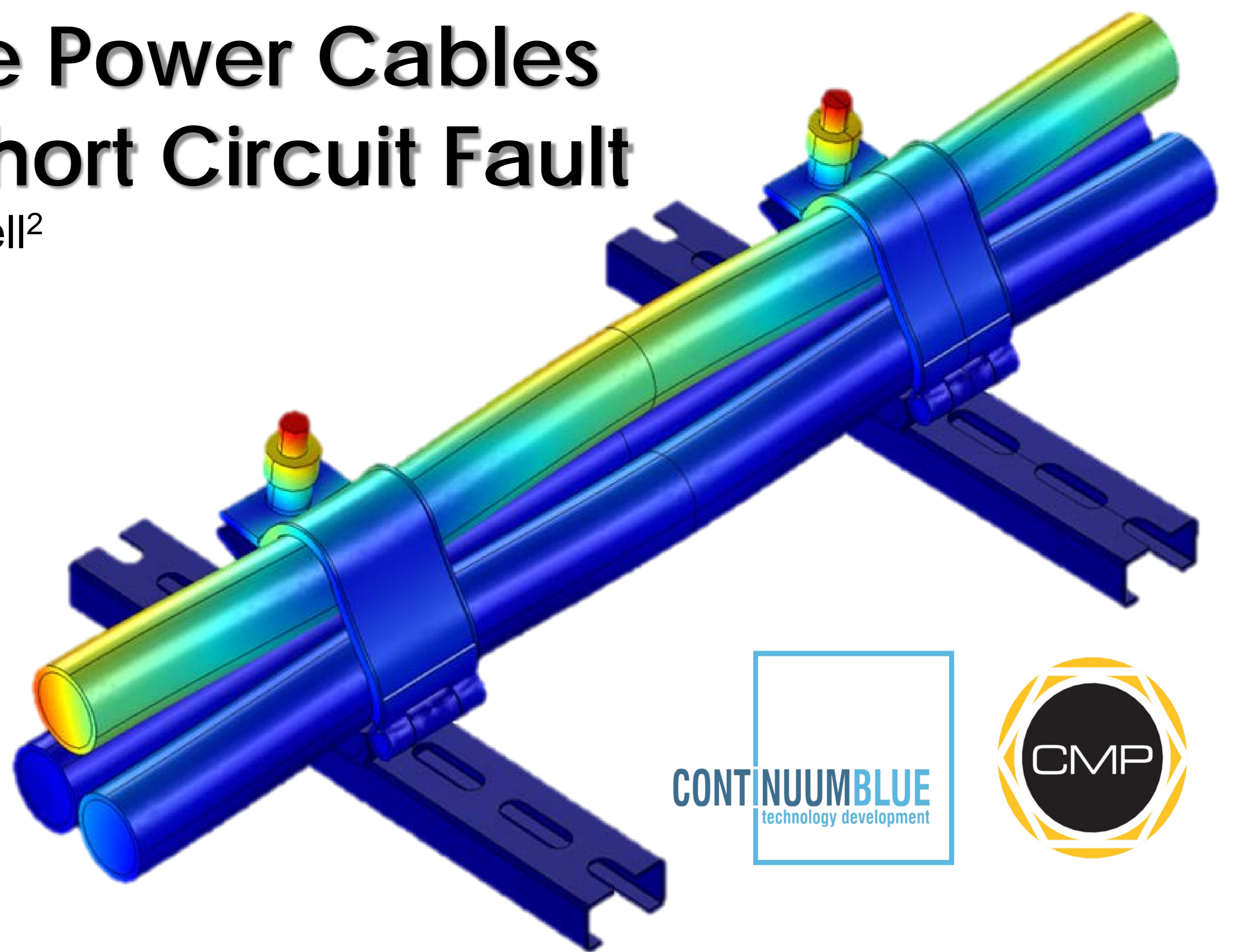

## RESULTS

The results of only one cleat design are presented (design 1), spaced at 300mm apart, holding 36mm diameter cables with conductor core areas of 500mm<sup>2</sup>, and a short-circuit fault load of 190kA (peak current). Figure 4 below presents the comparisons between the cleat stresses and displacements at various time points (2.5, 5 and 7.5 milliseconds) compared to the high speed images obtained from the physical tests. The displacements and deformed state of the cables and cleats follow those observed in the physical tests closely.

### Physical Test

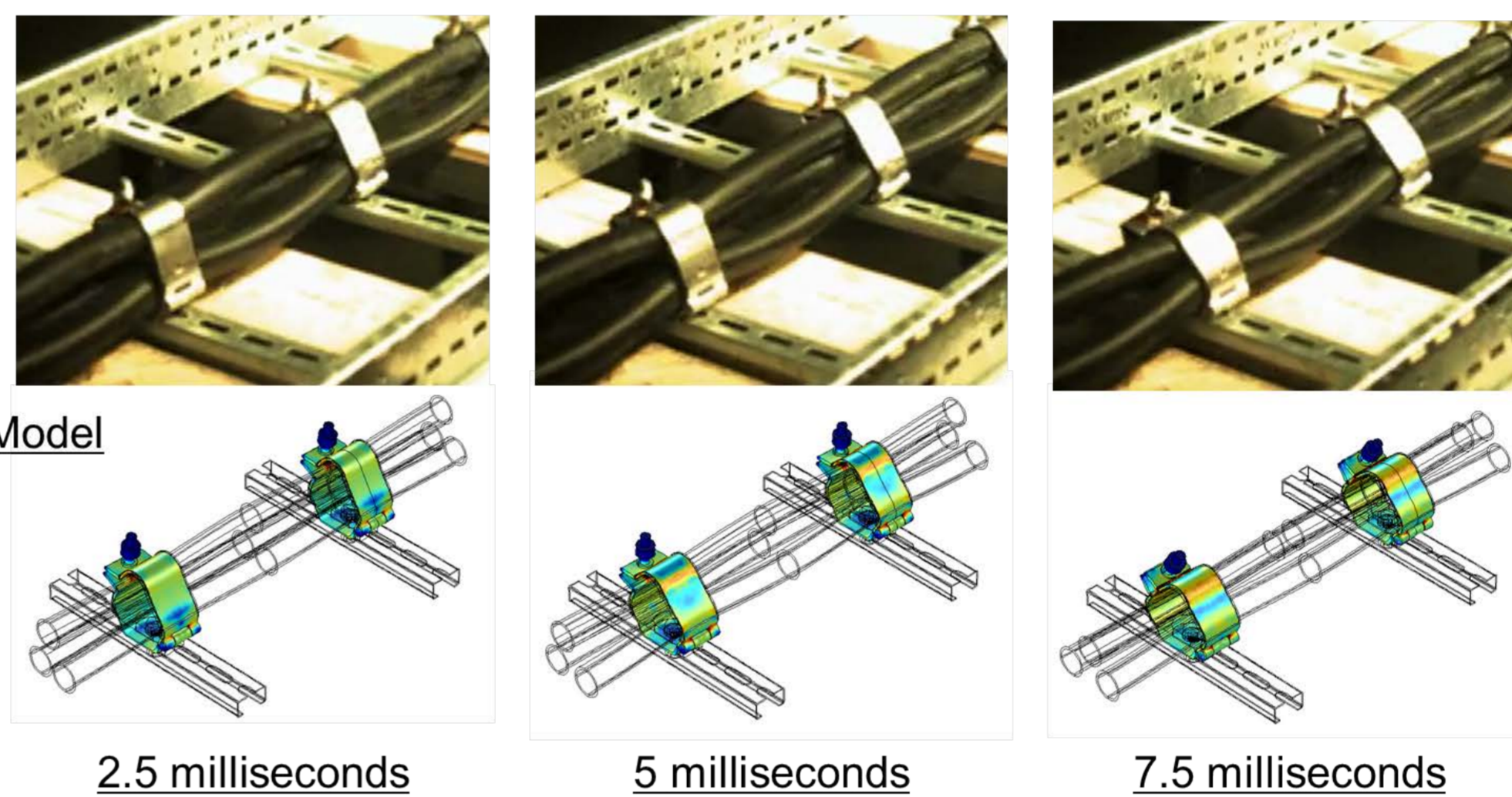

Figure 4. Comparison of model vs. physical test high speed data at various time points during short-circuit testing

Figure 5 below, presents the models final deformed state and included residual stresses, versus the physically tested cleat following the short-circuit simulation. From this figure, the model shows very good correlations to the physical test sample when assessing the angle of the bent clamping bolt & clasp. In addition to this, the multiphysics model predicted that the integrity of the cleat under the single short-circuit fault would not fail as seen in the physical tests.

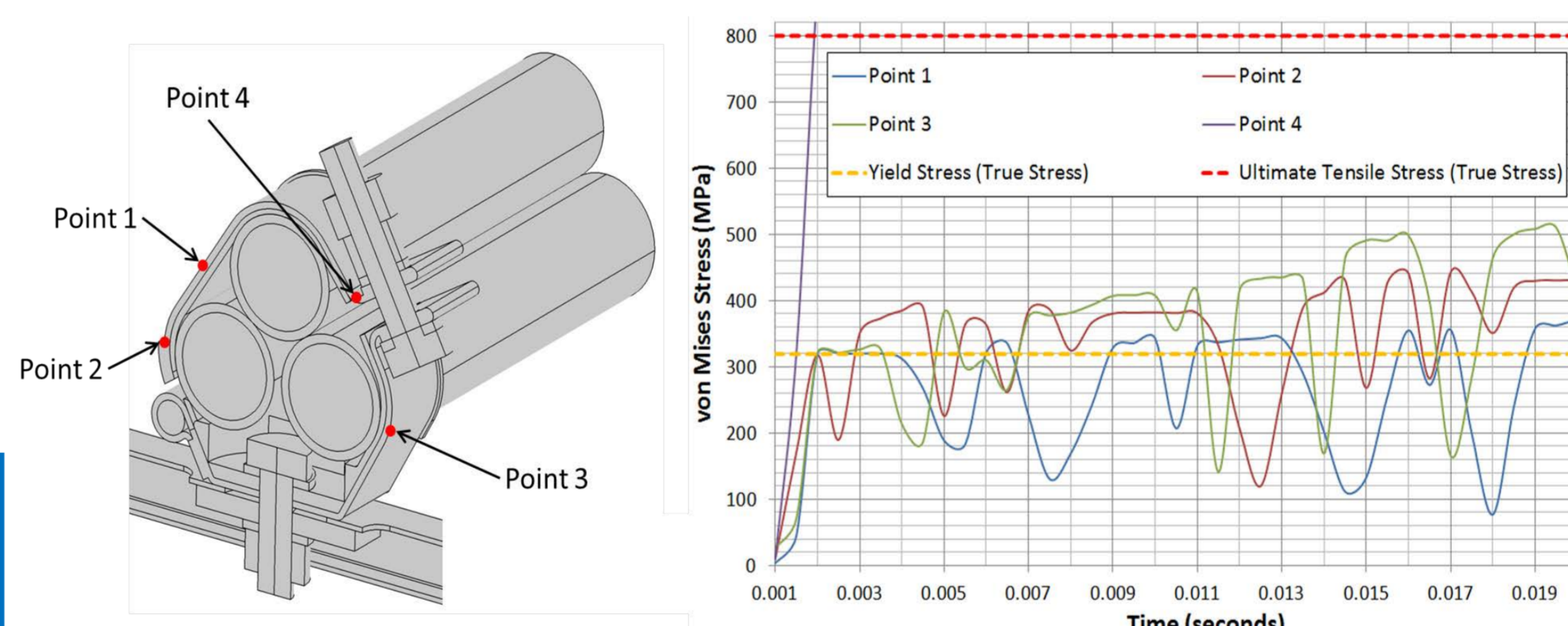
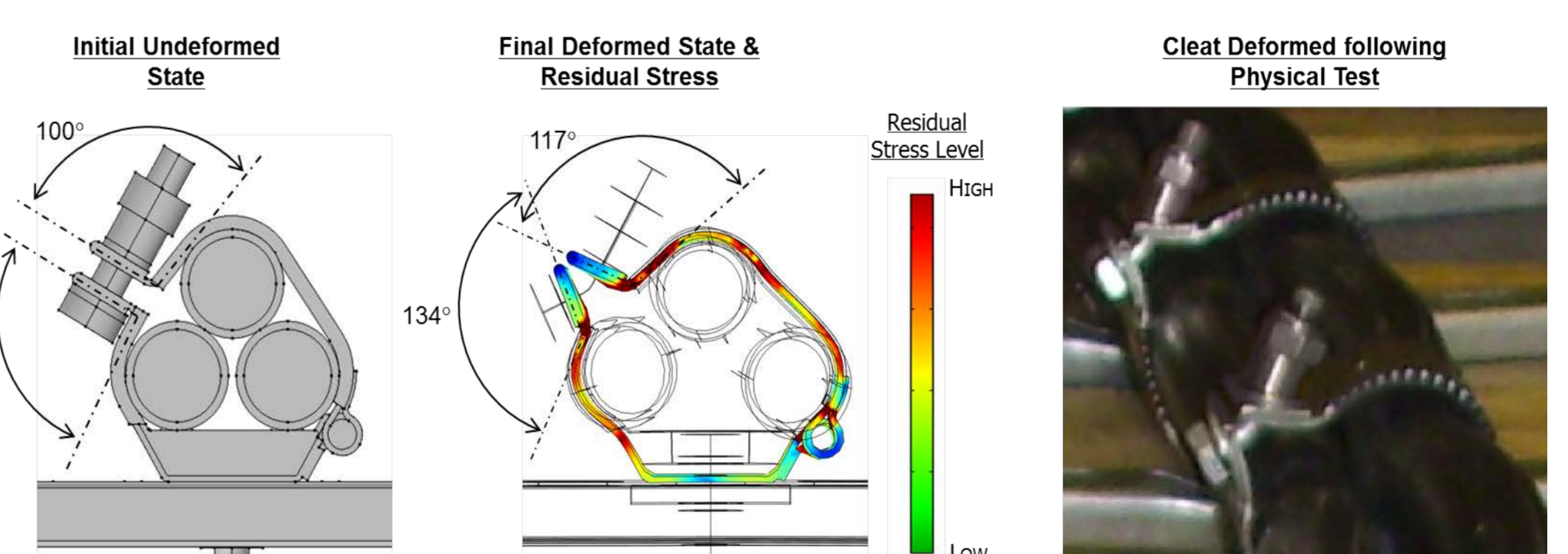

Figure 5. Analysis of stress at various points of interest on cleat vs. material yield & UTS values

Figure 6, presents the models final deformed state and included residual stresses, versus the physically tested cleat following the short-circuit simulation. From this figure, the model shows very good correlations to the physical test sample when assessing the angle of the bent clamping bolt & clasp. In addition to this, the multiphysics model predicted that the integrity of the cleat under the single short-circuit fault would not fail as seen in the physical tests.

Figure 6. Comparison of model cleat deformation vs. physical data following short-circuit simulation



## CONCLUSION

A fully coupled electromagnetic and structural multiphysics model has been developed to simulate the short-circuit electromechanical loading of cables and cable cleats in trefoil formation. The model has been validated against a number of cleat designs and electrical loads, and can be used to better understand the effects of cleat spacing, electrical load conditions, and cleat design changes to predict the success, or failure of the cable cleats in real-world installations, during single or multiple short-circuits faults.